

 Aluminum stand with 4 pcs. 2 x A4 brochure holders made of steel or acrylic. For indoor use.

 Aluminium Ständer, einseitig, mit 4 Stück 2 x A4 Prospekthalter aus Stahl oder Acryl. Für den Innenbereich.

 Aluminium stander monteret med 4 stk. 2 x A4 brochureholdere i stål eller akryl. Til indendørs brug.

FOR INDOOR USE!

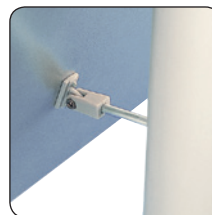
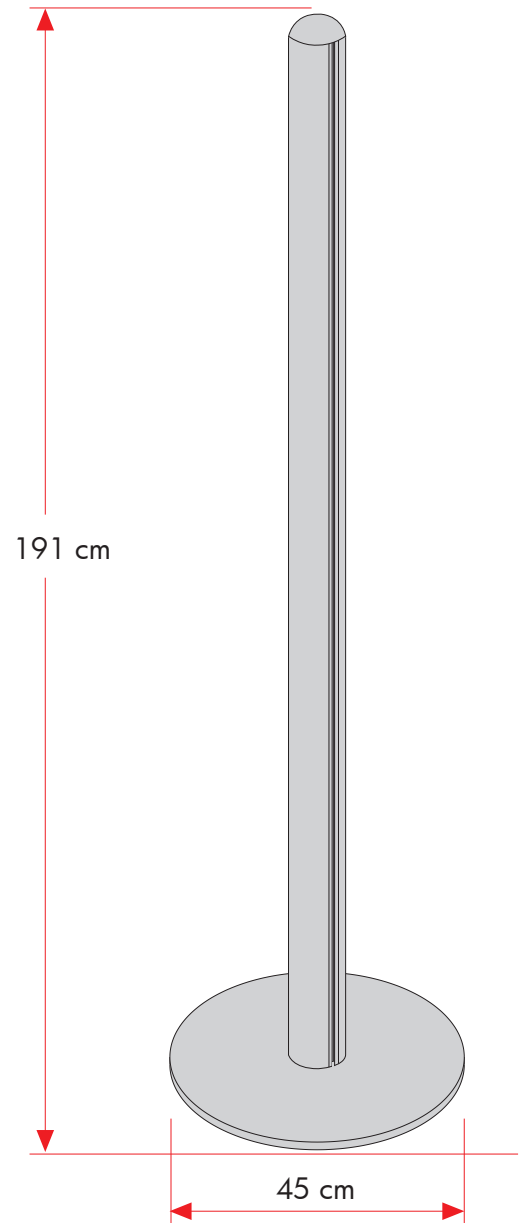
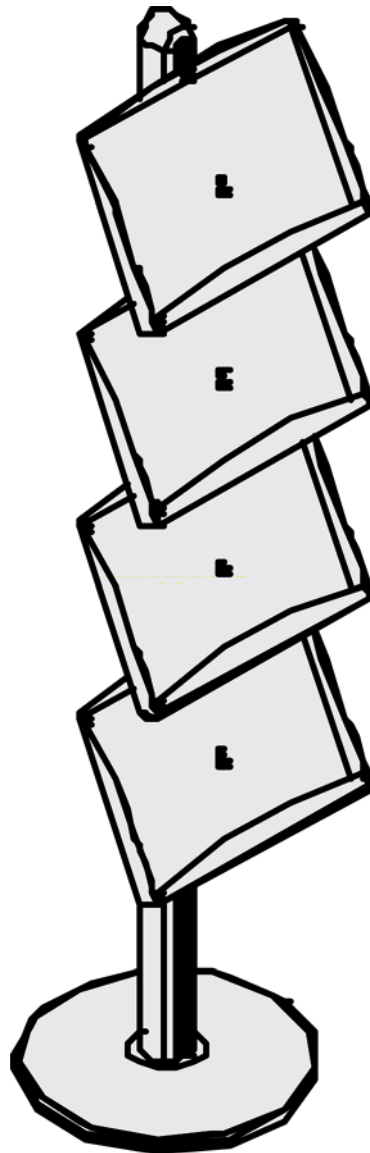

Model	Art.no.	Capacity	Colour	Total W x H	Base	Package size and weight	Pallet size and quantity
907	2970	29,7 x 42 cm A3	Alu	47 x 190 cm	Ø 45 cm	8x195x9 + 47x47x5 + 36x47x24 cm 20,0 kg	80 x 120 x 220 cm 30 pcs.
-	2971	-	Acrylic	47 x 190 cm	-	8x195x9 + 47x47x5 + 36x47x24 cm 17,0 kg	80 x 120 x 220 cm 30 pcs.

STEEL SHELF

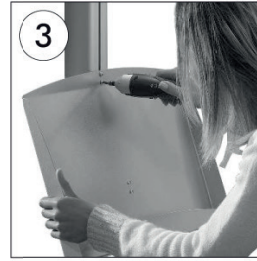
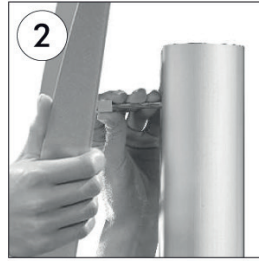
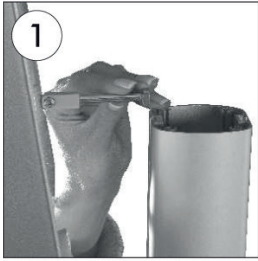

- Slide the back connectors of shelves through the channel of the pole.
- Die Mutter an der Rückseite der Ablagen sind indem Kanal an dem Mastprofil hineinzustecken.
- Raf arkasındaki somunları direk üzerindeki kanala sürerek rafı istenilen konuma getirin.

- Fix the shelves in desired height.
- Befestigen Sie die Schrauben an der Ablage.
- Rafi üzerindeki vidalardan sıkarak sabitleyin.

ACRYLIC SHELF

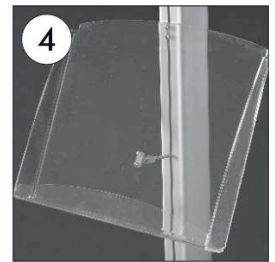
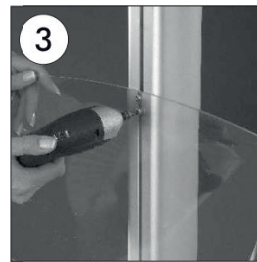
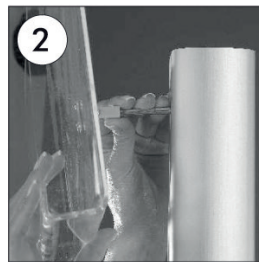
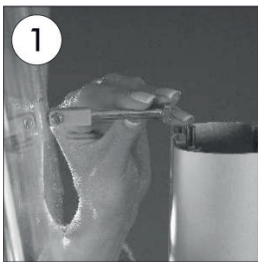

- Slide the back connectors of shelves through the channel of the pole.
- Die Mutter an der Rückseite der Ablagen sind indem Kanal an dem Mastprofil hineinzustecken.
- Raf arkasındaki somunları direk üzerindeki kanala sürerek rafı istenilen konuma getirin.

- Fix the shelves in desired height.
- Befestigen Sie die Schrauben an der Ablage.
- Rafi üzerindeki vidalardan sıkarak sabitleyin.

